

FLUOR-O-FLO®
PTFE NPT Piping System

PTFE Schedule 80 Pipe
PTFE NPT Threaded Fittings



CONTENTS PAGE

Pipe

• Pipe - Schedule 80 2

Fittings

• Nipples - Schedule 80 2

• Elbows - 90° 3

• Elbows - 45° 3

• Street Elbows 4

• Tees 4

• Straight Couplings 5

• Reducing Couplings 5

• Bushings 6

• Plugs 6

• Caps 7

• Unions 7

• Male NPT to Hose Barbs 8

• Female NPT to Hose Barbs 8

• Flanges - Threaded FNPT 9

• Flange Adapters - MNPT 9

• Male NPT to Tri-Clamp Adapters 10

Special Fittings

• Tank Adapters (Bulkhead Fittings) 10

• Manifolds 11

• Quick-Connect Coupling 12, 13

Specifications

• Engineering Specifications..... 14

All sales are subject to separately published Terms and Conditions of Sale.

Also available:
FLUOR-O-FLO® PTFE Piping System

- Sales Bulletin
- Installation Instructions
- Pressure Ratings
- Installation Tool Kits
- Sample Case

Pipe - Schedule 80

Nominal Pipe Size	Part No. (See Notes)	PIPE OD Min./Max.	Wall Min./Max.	Weight (lb./ft.)
1/8"	F-P01NN	0.405 / 0.435	0.095 / 0.155	0.1
1/4"	F-P02NN	0.540 / 0.570	0.119 / 0.179	0.2
3/8"	F-P03NN	0.675 / 0.705	0.126 / 0.186	0.2
1/2"	F-P04NN	0.840 / 0.870	0.147 / 0.207	0.3
3/4"	F-P06NN	1.050 / 1.085	0.154 / 0.234	0.5
1"	F-P08NN	1.315 / 1.350	0.179 / 0.259	0.7
1-1/4"	F-P10NN	1.660 / 1.695	0.191 / 0.271	0.9
1-1/2"	F-P12NN	1.900 / 1.935	0.200 / 0.280	1.2
2"	F-P16NN	2.375 / 2.415	0.218 / 0.338	1.6
2-1/2"	F-P20NN	2.875 / 2.935	0.276 / 0.396	2.4
3"	F-P24NN	3.500 / 3.575	0.300 / 0.450	3.3
4"	F-P32NN	4.500 / 4.575	0.337 / 0.487	4.8

Standard product is 8 feet long with ends unthreaded. Shorter lengths and lengths up to 20 feet or more are available upon request. NPT threading available for all lengths.

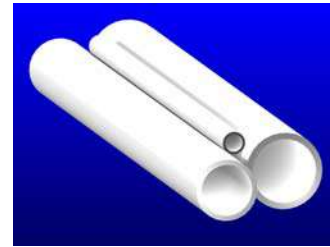

Note 1: For standard 8 foot lengths - replace NN with 96. For lengths other than standard, replace NN with length in inches.

Note 2: Add TBE for NPT Threaded Both Ends. Add TOE for NPT Threaded One End.

Product Specifications 2.1-2

Nipples - Schedule 80

Nominal Pipe Size	CLOSE NIPPLES			SHORT NIPPLES			OTHER LENGTHS TO 12 INCHES (See Notes)	
	Part No.	L	Weight (lb.)	Part No.	L	Weight (lb.)	Part No.	Weight (lb./in.)
1/8"	F-N01C	3/4"	0.01	F-N01S	1-1/2"	0.01	F-N01NN	0.01
1/4"	F-N02C	7/8"	0.01	F-N02S	1-1/2"	0.02	F-N02NN	0.01
3/8"	F-N03C	1"	0.02	F-N03S	1-1/2"	0.03	F-N03NN	0.02
1/2"	F-N04C	1-1/8"	0.03	F-N04S	1-1/2"	0.04	F-N04NN	0.03
3/4"	F-N06C	1-3/8"	0.05	F-N06S	2"	0.08	F-N06NN	0.04
1"	F-N08C	1-1/2"	0.08	F-N08S	2"	0.11	F-N08NN	0.06
1-1/4"	F-N10C	1-5/8"	0.13	F-N10S	2-1/2"	0.20	F-N10NN	0.08
1-1/2"	F-N12C	1-3/4"	0.17	F-N12S	2-1/2"	0.24	F-N12NN	0.10
2"	F-N16C	2"	0.27	F-N16S	2-1/2"	0.33	F-N16NN	0.13
2-1/2"	F-N20C	2-1/2"	0.50	F-N20S	3"	0.60	F-N20NN	0.20
3"	F-N24C	2-5/8"	0.71	F-N24S	3"	0.82	F-N24NN	0.27
4"	F-N32C	2-7/8"	1.1	F-N32S	4"	1.6	F-N32NN	0.40

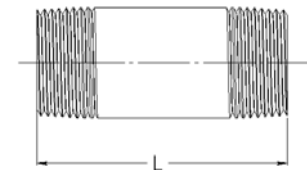
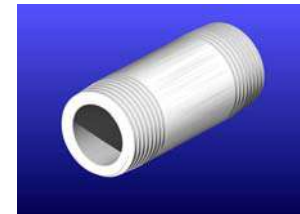

Note 1: Replace NN with length in inches.

Note 2: For Nipples over 12" long, use Threaded Pipe.



Elbows - 90°

Nominal Pipe Size	Part No.	L	C	F	Weight (lb.)
1/8"	F-90E01	1"	11/16"	5/8"	0.03
1/4"	F-90E02	1-1/4"	13/16"	7/8"	0.07
3/8"	F-90E03	1-3/8"	7/8"	1"	0.09
1/2"	F-90E04	1-13/16"	1-7/32"	1-3/16"	0.17
3/4"	F-90E06	2"	1-5/16"	1-3/8"	0.23
1"	F-90E08	2-3/8"	1-1/2"	1-3/4"	0.44
1-1/4"	F-90E10	2-11/16"	1-11/16"	2"	0.68
1-1/2"	F-90E12	3-1/8"	1-15/16"	2-3/8"	0.95
2"	F-90E16	3-5/8"	2-3/16"	2-7/8"	1.5
2-1/2"	F-90E20	4-3/8"	2-5/8"	3-1/2"	2.3
3"	F-90E24	5"	3"	4"	3.4
4"	F-90E32	6-3/8"	3-13/16"	5-1/8"	6.7

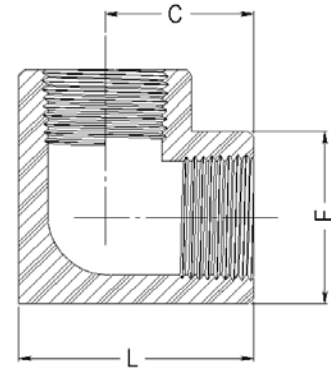
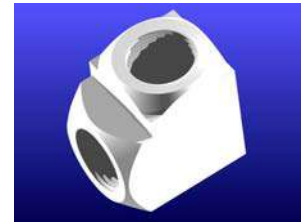

Elbows - 45°

Nominal Pipe Size	Part No.	L	C	F	Weight (lb.)
1/8"	F-45E01	1-3/16"	9/16"	5/8"	0.02
1/4"	F-45E02	1-3/8"	5/8"	7/8"	0.06
3/8"	F-45E03	1-1/2"	21/32"	1"	0.08
1/2"	F-45E04	2-3/32"	31/32"	1-3/16"	0.15
3/4"	F-45E06	2-1/4"	1-1/32"	1-3/8"	0.16
1"	F-45E08	2-9/16"	1-1/8"	1-3/4"	0.31
1-1/4"	F-45E10	2-21/32"	1-5/32"	2"	0.49
1-1/2"	F-45E12	3-5/16"	1-7/16"	2-3/8"	0.69
2"	F-45E16	3-3/4"	1-19/32"	2-7/8"	1.2
2-1/2"	F-45E20	5"	2-7/32"	3-1/2"	1.8
3"	F-45E24	5-1/8"	2-5/32"	4"	2.7
4"	F-45E32	6-11/32"	2-21/32"	5-1/8"	5.7

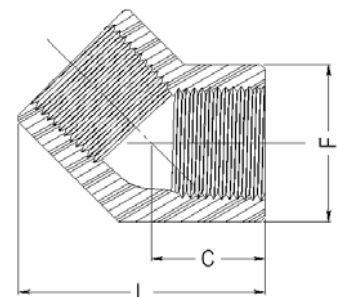
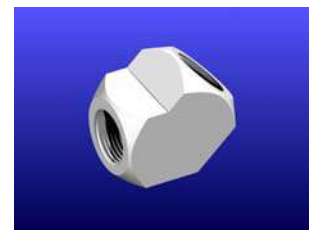

Street Elbows

Nominal Pipe Size	Part No.	L	H	F	Weight (lb.)
1/8"	F-90E01S	1-3/8"	1"	5/8"	0.04
1/4"	F-90E02S	1-11/16"	1-1/4"	7/8"	0.06
3/8"	F-90E03S	1-7/8"	1-3/8"	1"	0.10
1/2"	F-90E04S	2-3/16"	1-13/16"	1-3/16"	0.21
3/4"	F-90E06S	2-3/8"	2"	1-3/8"	0.27
1"	F-90E08S	2-7/8"	2-3/8"	1-3/4"	0.48
1-1/4"	F-90E10S	3-1/8"	2-11/16"	2"	0.63
1-1/2"	F-90E12S	3-5/8"	3-1/8"	2-3/8"	1.0
2"	F-90E16S	4-1/8"	3-5/8"	2-7/8"	1.5
2-1/2"	F-90E20S	5-1/4"	4-3/8"	3-1/2"	2.2
3"	F-90E24S	5-3/4"	5"	4"	3.3
4"	F-90E32S	6-3/4"	6-3/8"	5-1/8"	6.4

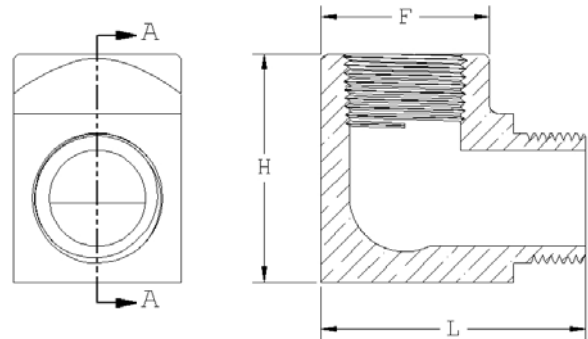
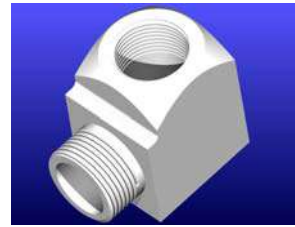

Product Specifications 2.1-2

Tees

Nominal Pipe Size	Part No.	L	H	F	Weight (lb.)
1/8"	F-TE01	1-3/8"	1"	5/8"	0.04
1/4"	F-TE02	1-5/8"	1-1/4"	7/8"	0.06
3/8"	F-TE03	1-3/4"	1-3/8"	1"	0.10
1/2"	F-TE04	2-7/16"	1-13/16"	1-3/16"	0.21
3/4"	F-TE06	2-5/8"	2"	1-3/8"	0.27
1"	F-TE08	3"	2-3/8"	1-3/4"	0.48
1-1/4"	F-TE10	3-3/8"	2-11/16"	2"	0.63
1-1/2"	F-TE12	3-7/8"	3-1/8"	2-3/8"	1.0
2"	F-TE16	4-3/8"	3-5/8"	2-7/8"	1.5
2-1/2"	F-TE20	5-1/4"	4-3/8"	3-1/2"	2.2
3"	F-TE24	6"	5"	4"	3.3
4"	F-TE32	7-5/8"	6-3/8"	5-1/8"	6.4

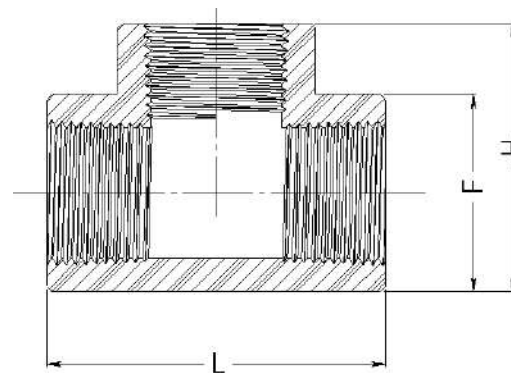

Note: Reducing Tees are made to the same dimensions.



Straight Couplings

Nominal Pipe Size	Part No.	OD	L	Weight (lb.)
1/8"	F-SC01	5/8"	15/16"	0.03
1/4"	F-SC02	7/8"	1-1/8"	0.04
3/8"	F-SC03	1"	1-1/4"	0.05
1/2"	F-SC04	1-3/16"	1-3/8"	0.07
3/4"	F-SC06	1-3/8"	1-1/2"	0.11
1"	F-SC08	1-3/4"	1-5/8"	0.20
1-1/4"	F-SC10	2"	2"	0.29
1-1/2"	F-SC12	2-3/8"	2-1/8"	0.40
2"	F-SC16	2-7/8"	2-1/2"	0.50
2-1/2"	F-SC20	3-1/2"	2-5/8"	0.72
3"	F-SC24	4"	3-1/4"	1.0
4"	F-SC32	5-1/8"	4-1/4"	1.9

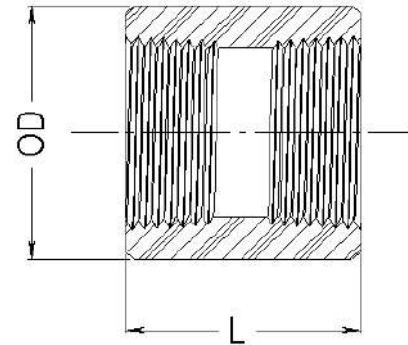
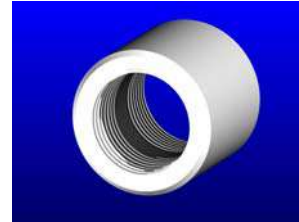

Product Specifications 2.1-2

Reducing Couplings

Nominal Pipe Size	Part No.	OD	L	Weight (lb.)
1/8"	Contact Factory			
1/4"	F-RC02 <u>NN</u>	7/8"	1-1/8"	0.04
3/8"	F-RC03 <u>NN</u>	1"	1-1/4"	0.05
1/2"	F-RC04 <u>NN</u>	1-3/16"	1-3/8"	0.07
3/4"	F-RC06 <u>NN</u>	1-3/8"	1-1/2"	0.11
1"	F-RC08 <u>NN</u>	1-3/4"	1-5/8"	0.20
1-1/4"	F-RC10 <u>NN</u>	2"	2"	0.29
1-1/2"	F-RC12 <u>NN</u>	2-3/8"	2-1/8"	0.40
2"	F-RC16 <u>NN</u>	2-7/8"	2-1/2"	0.50
2-1/2"	F-RC20 <u>NN</u>	3-1/2"	2-5/8"	0.72
3"	F-RC24 <u>NN</u>	4"	3-1/4"	1.0
4"	F-RC32 <u>NN</u>	5-1/8"	4-1/4"	1.9

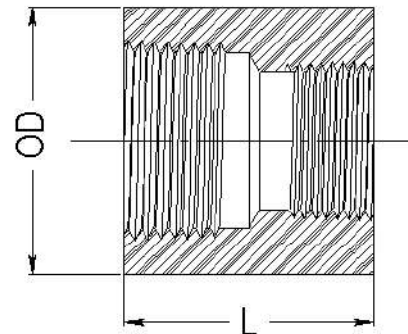

Note: Replace NN with minor pipe size expressed in the number of eighths. For example, for 1/4" x 1/8" size, use F-RC0201



Bushings

Male Pipe Size	Part No.	OD	L	Weight (lb.)
1/8"	Contact Factory			
1/4"	F-RB02 <u>NN</u>	11/16"	1"	0.01
3/8"	F-RB03 <u>NN</u>	15/16"	1-1/8"	0.02
1/2"	F-RB04 <u>NN</u>	1"	1-1/4"	0.03
3/4"	F-RB06 <u>NN</u>	1-1/4"	1-3/8"	0.05
1"	F-RB08 <u>NN</u>	1-1/2"	1-1/2"	0.10
1-1/4"	F-RB10 <u>NN</u>	1-13/16"	1-1/2"	0.18
1-1/2"	F-RB12 <u>NN</u>	2-3/16"	1-5/8"	0.30
2"	F-RB16 <u>NN</u>	2-3/4"	1-3/4"	0.60
2-1/2"	F-RB20 <u>NN</u>	3-1/4"	2-3/8"	0.92
3"	F-RB24 <u>NN</u>	3-7/8"	2-1/2"	1.3
4"	F-RB32 <u>NN</u>	5"	2-5/8"	2.8

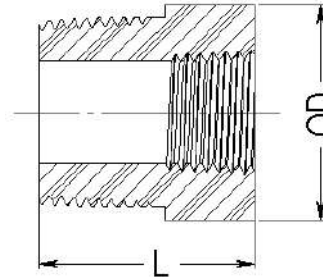
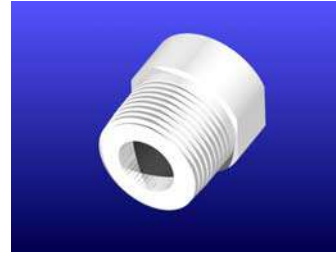

Note: Replace NN with FNPT size expressed in the number of eighths. For example, for 1/2" MNPT X 1/4" FNPT, use F-RB0402.

Product Specifications 2.1-2

Plugs

Nominal Pipe Size	Part No.	OD	L	Weight (lb.)
1/8"	F-PL01	0.405	3/4"	0.01
1/4"	F-PL02	0.540	13/16"	0.01
3/8"	F-PL03	0.675	7/8"	0.02
1/2"	F-PL04	0.840	1"	0.04
3/4"	F-PL06	1.050	1-1/4"	0.08
1"	F-PL08	1.315	1-3/8"	0.15
1-1/4"	F-PL10	1.660	1-5/8"	0.23
1-1/2"	F-PL12	1.900	1-3/4"	0.36
2"	F-PL16	2.375	1-7/8"	0.60
2-1/2"	F-PL20	2.875	2-1/8"	0.85
3"	F-PL24	3.500	2-3/8"	1.2
4"	F-PL32	4.500	2-1/2"	3.0

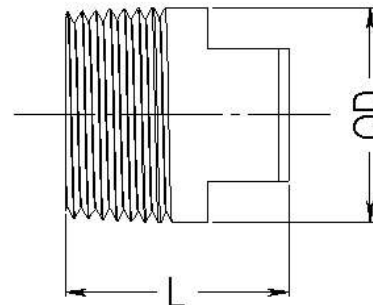

Caps

Nominal Pipe Size	Part No.	OD	L	Weight (lb.)
1/8"	F-CA01	5/8"	13/16"	0.02
1/4"	F-CA02	7/8"	15/16"	0.04
3/8"	F-CA03	1"	1"	0.05
1/2"	F-CA04	1-3/16"	1-1/32"	0.08
3/4"	F-CA06	1-3/8"	1-7/32"	0.09
1"	F-CA08	1-3/4"	1-5/8"	0.20
1-1/4"	F-CA10	2"	1-5/8"	0.24
1-1/2"	F-CA12	2-3/8"	1-3/4"	0.30
2"	F-CA16	2-7/8"	2"	0.55
2-1/2"	F-CA20	3-1/2"	2-3/32"	0.80
3"	F-CA24	4"	2-1/2"	1.3
4"	F-CA32	5-1/8"	2-1/2"	2.9

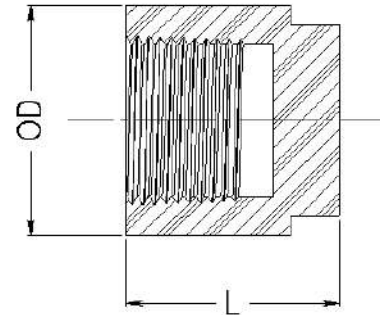

Product Specifications 2.1-2

Unions

Nominal Pipe Size	Part No.	OD	L	Weight (lb.)
1/8"	F-UN01	1-5/8"	1-1/4"	0.08
1/4"	F-UN02	1-5/8"	1-1/2"	0.13
3/8"	F-UN03	1-7/8"	1-5/8"	0.16
1/2"	F-UN04	2-1/8"	1-3/4"	0.20
3/4"	F-UN06	2-1/4"	2-1/8"	0.30
1"	F-UN08	2-5/8"	2-1/2"	0.45
1-1/4"	F-UN10	2-5/8"	2-3/4"	0.59
1-1/2"	F-UN12	2-15/16"	3-3/16"	0.73
2"	F-UN16	3-5/16"	3-3/4"	1.0
2-1/2"	F-UN20	3-7/16"	4-5/8"	1.4
3"	F-UN24	3-3/4"	5-1/8"	2.0
4"	F-UN32	3-3/4"	6-1/4"	3.5

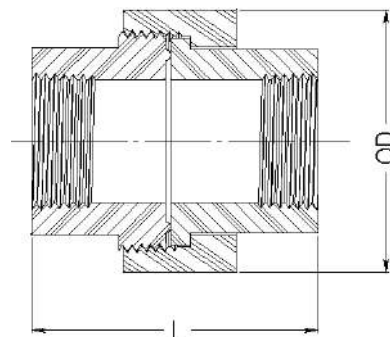
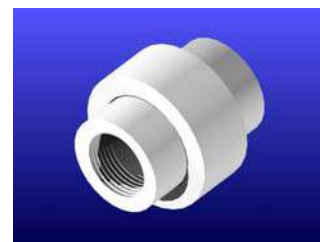

Male NPT to Hose Barbs

Nominal Pipe Size	Part No.	OD	L	Weight (lb.)
1/8"	F-MH01 <u>NN</u>	9/16"	1-3/8"	0.01
1/4"	F-MH02 <u>NN</u>	11/16"	1-3/4"	0.02
3/8"	F-MH03 <u>NN</u>	13/16"	2"	0.03
1/2"	F-MH04 <u>NN</u>	1"	2-1/4"	0.05
Contact Factory				
3/4"	F-MH06 <u>NN</u>	1-1/4"	2-5/8"	0.08
1"	F-MH08 <u>NN</u>	1-1/2"	2-3/4"	0.11
1-1/4"	Contact Factory			
1-1/2"				
2"				
2-1/2"				
3"				
4"				

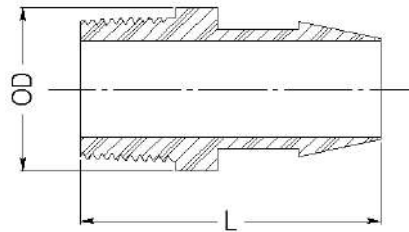

Note: Replace NN with Hose Barb size expressed in the number of eighths. For example, for 1/2" MNPT X 1/2" Hose Barb, use F-MH0404.

Product Specifications 2.1-2

Female NPT to Hose Barbs

Nominal Pipe Size	Part No.	OD	L	Weight (lb.)
1/8"	F-FH01 <u>NN</u>	5/8"	1-5/8"	0.01
1/4"	F-FH02 <u>NN</u>	7/8"	1-7/8"	0.02
3/8"	F-FH03 <u>NN</u>	1"	2-1/8"	0.03
1/2"	F-FH04 <u>NN</u>	1-3/16"	2-3/8"	0.06
Contact Factory				
3/4"	F-FH06 <u>NN</u>	1-3/8"	3"	0.09
1"	F-FH08 <u>NN</u>	1-3/4"	3-1/2"	0.13
1-1/4"	Contact Factory			
1-1/2"				
2"				
2-1/2"				
3"				
4"				

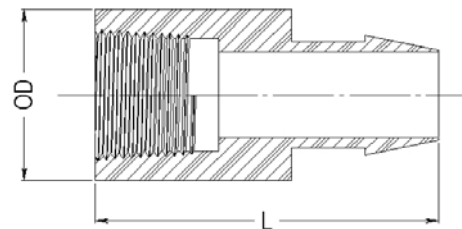
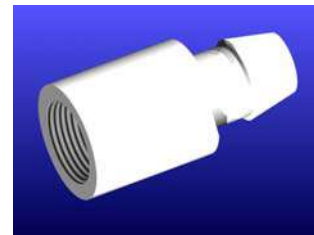

Note: Replace NN with Hose Barb size expressed in the number of eighths. For example, for 1/2" FNPT X 1/2" Hose Barb, use F-FH0404.



Female NPT Threaded Flanges - ANSI Class 150

Nominal Pipe Size	Part No.	OD	T	Number Bolt Holes	D	BC	Weight (lb.)
1/8"	Contact Factory						
1/4"							
3/8"							
1/2"	F-FL04	3-1/2"	3/4"	4	5/8"	2-3/8"	0.50
3/4"	F-FL06	3-7/8"	3/4"	4	5/8"	2-3/4"	0.70
1"	F-FL08	4-1/4"	3/4"	4	5/8"	3-1/8"	0.80
1-1/4"	F-FL10	4-5/8"	1"	4	5/8"	3-1/2"	1.05
1-1/2"	F-FL12	5"	1"	4	5/8"	3-7/8"	1.40
2"	F-FL16	6"	1"	4	3/4"	4-3/4"	1.90
2-1/2"	F-FL20	7"	1-1/4"	4	3/4"	5-1/2"	3.13
3"	F-FL24	7-1/2"	1-1/4"	4	3/4"	6"	3.60
4"	F-FL32	9"	1-1/2"	8	3/4"	7-1/2"	6.50

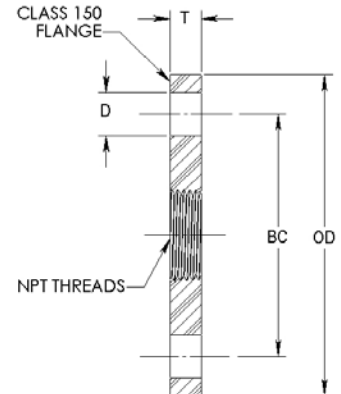
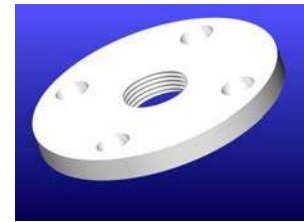

Note: Other flange materials available, *Contact Factory*

Product Specifications 2.1-2

Male NPT to Flange Adapters

Nominal Pipe Size	PTFE STUB END ONLY				STUB END WITH PVC FLANGE		STUB END WITH PVDF FLANGE	
	Part No.	OD	L	Weight (lb.)	Part No.	Weight (lb.)	Part No.	Weight (lb.)
1/8"	Contact Factory							
1/4"								
3/8"								
1/2"	F-FLS04	1-3/8"	2-1/2"	0.10	F-FLA04C	0.26	F-FLA04F	0.29
3/4"	F-FLS06	1-11/16"	2-1/2"	0.14	F-FLA06C	0.36	F-FLA06F	0.41
1"	F-FLS08	2"	3"	0.22	F-FLA08C	0.50	F-FLA08F	0.58
1-1/4"	F-FLS10	2-1/2"	3"	0.31	F-FLA10C	0.64	F-FLA10F	0.73
1-1/2"	F-FLS12	2-7/8"	3"	0.38	F-FLA12C	0.79	F-FLA12F	0.89
2"	F-FLS16	3-5/8"	3"	0.57	F-FLA16C	1.2	F-FLA16F	1.4
2-1/2"	F-FLS20	4-1/8"	4"	1.0	F-FLA20C	2.0	F-FLA20F	2.2
3"	F-FLS24	5"	4"	1.4	F-FLA24C	2.5	F-FLA24F	2.7
4"	F-FLS32	6-3/16"	4"	2.0	F-FLA32C	3.4	F-FLA32F	3.8

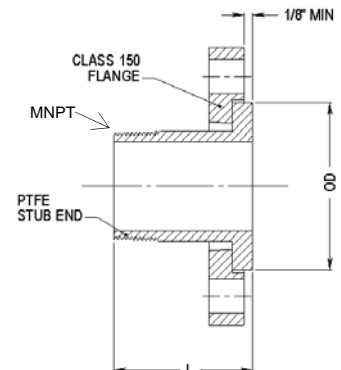
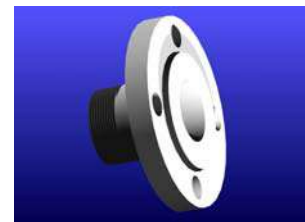

Note: Other flange materials available, *Contact Factory*



Adapters - Male NPT to Tri-Clamp

Nominal Pipe Size	Part No.	OD	L	Weight (lb.)
1/8" X 1/8"	F-TCA01NN	0.992"	2-1/8"	0.1
1/4" X 1/4"	F-TCA02NN	0.992"	2-3/16"	0.1
3/8" X 3/8"	F-TCA03NN	0.992"	2-1/4"	0.1
1/2" X 1/2"	F-TCA04NN	0.992"	2-3/8"	0.1
3/4" X 3/4"	F-TCA06NN	0.992"	2-3/8"	0.1
1" X 1"	F-TCA08NN	1.984"	2-3/4"	0.2
1-1/2" X 1-1/2"	F-TCA12NN	1.984"	3-1/8"	0.2
2" X 2"	F-TCA16NN	2.515"	3-3/8"	0.4
2-1/2" X 2-1/2"	F-TCA20NN	3.050"	3-7/8"	0.7
3" X 3"	F-TCA24NN	3.579"	3-7/8"	0.9
4" X 4"	F-TCA32NN	4.682"	4-1/4"	1.5

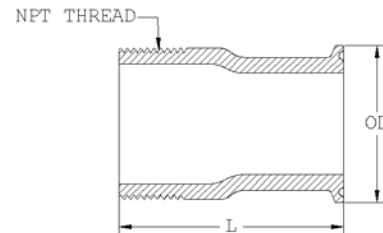

Note: Replace NN with Tri-Clamp size expressed in the number of eighths. For example, for 1/2" MNPT X 1/2" Tri-Clamp, use F-TCA0404.

Tank Adapters (Bulkhead Fittings)

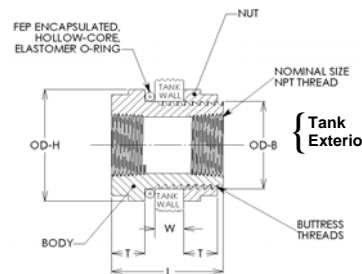

Nominal Pipe Size	PTFE Part No. (Note 1)	PVDF FNPT Threaded Part No.	PVDF IPS Socket Weld Part No.	PVDF Metric Socket Weld Part No.	OD-H	T	OD-B	L	W MAX (Note 2)	MIN. TANK DIA. (Note 3)	Weight (lb.)
1/8"	F-TA01	N/A	N/A	N/A	1-5/8"	1/2"	1-1/8"	1-3/4"	1/2"	12"	0.20
1/4"	F-TA02	N/A	N/A	N/A	1-11/16"	1/2"	1-3/16"	1-3/4"	1/2"	13"	0.20
3/8"	F-TA03	FK-TA03FT	FK-TA03SI	FK-TA03SM	1-13/16"	1/2"	1-9/32"	1-3/4"	1/2"	15"	0.20
1/2"	F-TA04	FK-TA04FT	FK-TA04SI	FK-TA03SM	2-1/16"	5/8"	1-1/2"	2-1/8"	5/8"	19"	0.35
3/4"	F-TA06	FK-TA06FT	FK-TA06SI	FK-TA06SM	2-3/8"	3/4"	1-13/16"	2-1/2"	3/4"	25"	0.55
1"	F-TA08	FK-TA08FT	FK-TA08SI	FK-TA08SM	2-5/8"	3/4"	2-1/16"	2-1/2"	3/4"	32"	0.65
1-1/4"	F-TA10	FK-TA10FT	FK-TA10SI	FK-TA10SM	2-7/8"	3/4"	2-3/8"	2-1/2"	3/4"	44"	0.70
1-1/2"	F-TA12	FK-TA12FT	FK-TA12SI	FK-TA12SM	3-1/8"	3/4"	2-5/8"	2-1/2"	3/4"	53"	0.80
2"	F-TA16	FK-TA16FT	FK-TA16SI	FK-TA16SM	3-5/8"	7/8"	3-1/8"	2-7/8"	7/8"	73"	1.15
2-1/2"	F-TA20	FK-TA20FT	FK-TA20SI	FK-TA20SM	4-1/4"	1-1/8"	3-5/8"	3-3/8"	7/8"	97"	2.01
3"	F-TA24	FK-TA24FT	FK-TA24SI	FK-TA24SM	5-1/8"	1-1/4"	4-1/2"	3-3/4"	1"	146"	2.95
4"	F-TA32	FK-TA32FT	FK-TA32SI	FK-TA32SM	6-1/4"	1-3/8"	5-1/2"	4"	1"	216"	4.52

Note 1: Standard fitting includes FEP encapsulated, 0.210" diameter, silicone o-ring. PFA encapsulation, PTFE, or other o-ring materials available.

Note 2: Body can be made longer to accommodate thicker tank walls.

Note 3: As supplied, fittings are suitable for use with flat-wall or most cylindrical, smooth-wall tanks to min. dia. shown. Custom adapters are available to permit use with smaller diameter tanks.



Manifolds

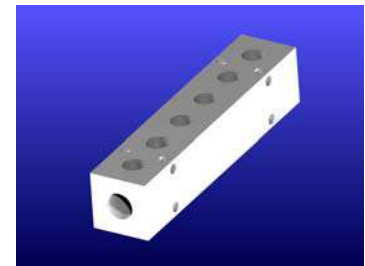
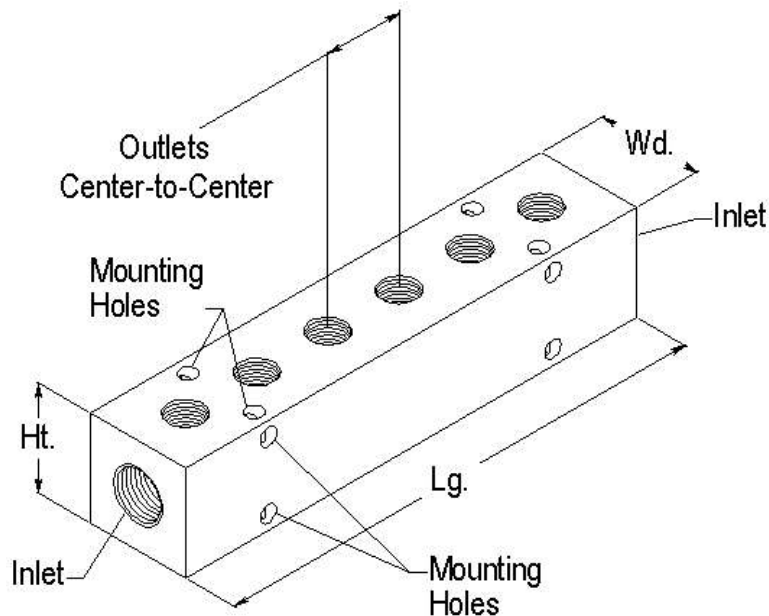

Nominal Size			Overall Size				
No. of Outlets	Inlet NPT Pipe Size	Outlet NPT Pipe Size	Part No	Lg. x Wd. x Ht.	Outlets, Center to Center	Mounting Hole Size	Weight (lb.)
2	1/4"	1/8"	F-MA0202C01	1-3/4" x 1" x 1"	3/4"	0.17"	0.1
2	3/8"	1/4"	F-MA020302	2-3/8" x 1-1/4" x 1-1/4"	7/8"	0.20"	0.3
2	1/2"	3/8"	F-MA020403	2-3/4" x 1-1/2" x 1-1/2"	1"	0.20"	0.4
4	1/4"	1/8"	F-MA040201	3-1/4" x 1" x 1"	3/4"	0.17"	0.2
4	3/8"	1/4"	F-MA040302	4-1/8" x 1-1/4" x 1-1/4"	7/8"	0.20"	0.5
4	1/2"	3/8"	F-MA040403	4-3/4" x 1-1/2" x 1-1/2"	1"	0.20"	0.7
6	1/4"	1/8"	F-MA060201	4-3/4" x 1" x 1"	3/4"	0.17"	0.3
6	3/8"	1/4"	F-MA060302	5-7/8" x 1-1/4" x 1-1/4"	7/8"	0.20"	0.6
6	1/2"	3/8"	F-MA060403	6-3/4" x 1-1/2" x 1-1/2"	1"	0.20"	1.0
8	1/4"	1/8"	F-MA080201	6-1/4" x 1" x 1"	3/4"	0.17"	0.4
8	3/8"	1/4"	F-MA080302	7-5/8" x 1-1/4" x 1-1/4"	7/8"	0.20"	0.8
8	1/2"	3/8"	F-MA080403	8-3/4" x 1-1/2" x 1-1/2"	1"	0.20"	1.4
10	1/4"	1/8"	F-MA100201	7-3/4" x 1" x 1"	3/4"	0.17"	0.6
10	3/8"	1/4"	F-MA100302	9-3/8" x 1-1/4" x 1-1/4"	7/8"	0.20"	1.0
10	1/2"	3/8"	F-MA100403	10-3/4" x 1-1/2" x 1-1/2"	1"	0.20"	1.7



Cam-Lock, Quick-Connect Coupling

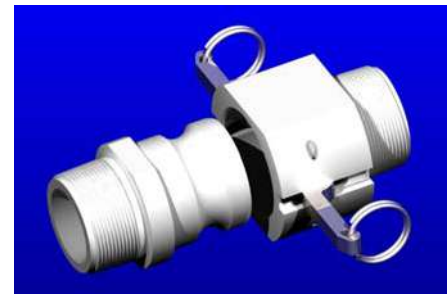

See detailed drawing on next page.

Nominal Pipe Size	Part No.	Basic Body Size	A	B	C	D	E	F	G	H	Weight (lbs.)
Half-Coupling Type: Male w/Female NPT Threads											
1/4"	CLMFT02	A	1.95	0.83	1.56	0.72	1.40	N/A	N/A	N/A	0.16
3/8"	CLMFT03										
1/2"	CLMFT04										
3/4"	CLMFT06	B	2.43	1.05	1.82	0.88	1.69	N/A	N/A	N/A	0.22
1"	CLMFT08										
1-1/4"	CLMFT10	C	3.46	1.46	2.90	1.75	2.63	N/A	N/A	N/A	0.71
1-1/2"	CLMFT12										
2"	CLMFT16										
Half-Coupling Type: Male w/Male NPT Threads											
1/4"	CLMMT02	A	2.31	1.18	1.56	0.55	1.40	N/A	N/A	N/A	0.14
3/8"	CLMMT03										
1/2"	CLMMT04										
3/4"	CLMMT06	B	3.21	1.84	1.82	0.88	1.58	N/A	N/A	N/A	0.24
1"	CLMMT08										
1-1/4"	CLMMT10	C	3.91	1.91	2.90	1.75	2.63	N/A	N/A	N/A	0.73
1-1/2"	CLMMT12										
2"	CLMMT16										
Half-Coupling Type: Female w/Female NPT Threads											
1/4"	CLFFT02	A	2.15	1.30	N/A	0.72	N/A	1.75	2.45	3.62	0.40
3/8"	CLFFT03										
1/2"	CLFFT04										
3/4"	CLFFT06	B	2.74	1.69	N/A	0.88	N/A	2.00	2.26	4.75	0.64
1"	CLFFT08										
1-1/4"	CLFFT10	C	3.13	2.23	N/A	1.75	N/A	3.00	3.90	7.80	1.38
1-1/2"	CLFFT12										
2"	CLFFT16										
Half-Coupling Type: Female w/Male NPT Threads											
1/4"	CLFMT02	A	2.18	1.30	N/A	0.55	N/A	1.75	2.45	3.62	0.31
3/8"	CLFMT03										
1/2"	CLFMT04										
3/4"	CLFMT06	B	2.97	1.69	N/A	0.88	N/A	2.00	2.26	4.75	0.56
1"	CLFMT08										
1-1/4"	CLFMT10	C	3.48	2.23	N/A	1.75	N/A	3.00	3.90	7.80	1.37
1-1/2"	CLFMT12										
2"	CLFMT16										

Notes:

- All dimensions given above in inches except weights, which are given in pounds.
- Female half-couplings of either thread type may be combined with male half-couplings of either thread type.
- Half-couplings within each of the three basic body size ranges may be interchanged if needed to mate disparate pipe sizes. Thus, P/N CLFFT02, an A size female half coupling with 1/4" female NPT threads may be combined with P/N CLMMT04, an A size male half-coupling with 1/2" male NPT threads.
- For pressure versus temperature ratings for each size, see Micromold's FLUOR-O-FLO® PTFE Threaded Piping System Pressure Rating Chart at <http://catalog.micromold.com/asset/fof-pressure-graph-technical-bulletin.pdf>.



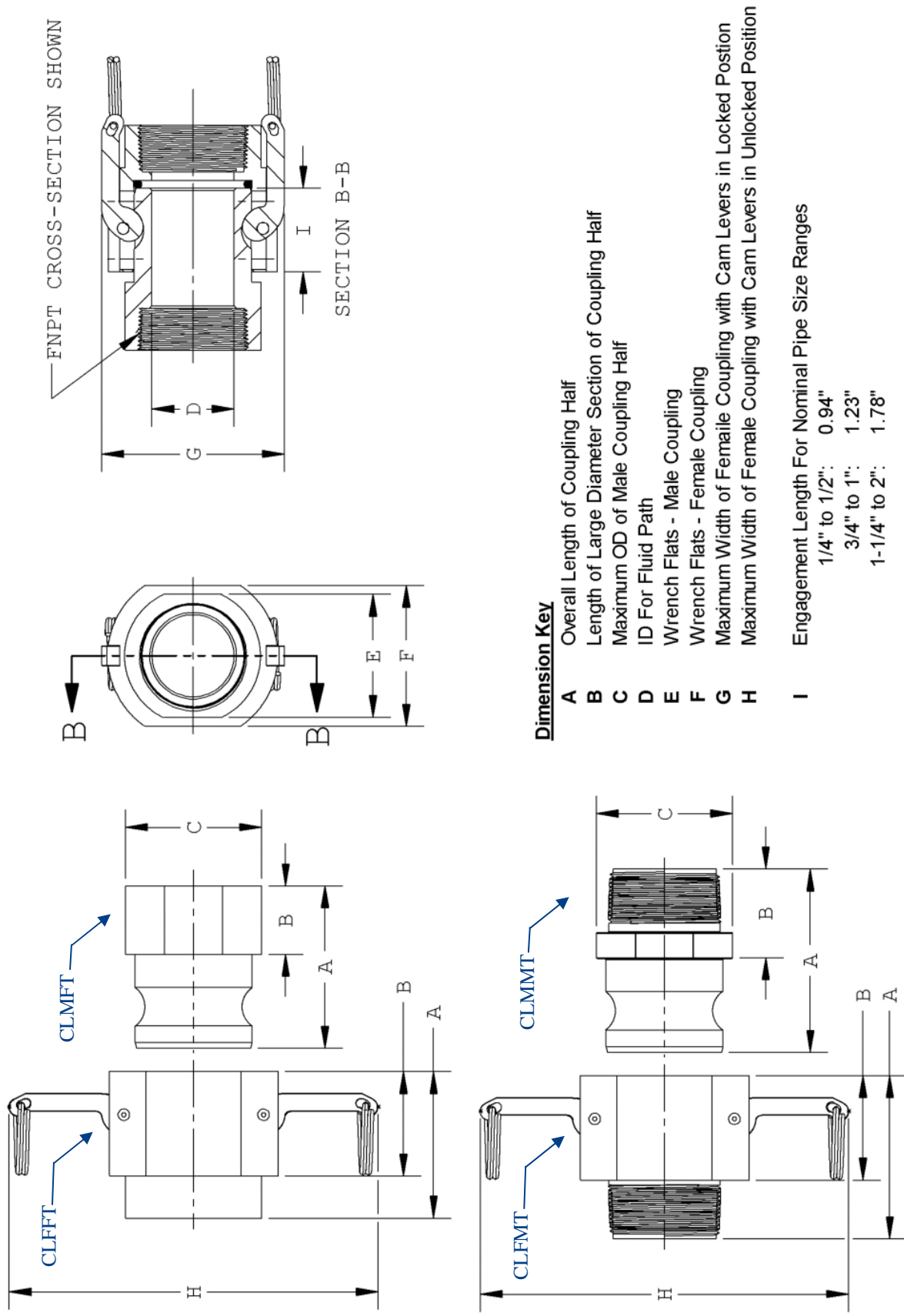

Dimension Key

- A** Overall Length of Coupling Half
- B** Length of Large Diameter Section of Coupling Half
- C** Maximum OD of Male Coupling Half
- D** ID For Fluid Path
- E** Wrench Flats - Male Coupling
- F** Wrench Flats - Female Coupling
- G** Maximum Width of Female Coupling with Cam Levers in Locked Position
- H** Maximum Width of Female Coupling with Cam Levers in Unlocked Position
- I** Engagement Length For Nominal Pipe Size Ranges
 - 1/4" to 1/2": 0.94"
 - 3/4" to 1": 1.23"
 - 1-1/4" to 2": 1.78"



FLUOR-O-FLO® NPT Threaded Piping System - PTFE Engineering Specifications

All pipe in sizes 1/8” through 4” shall be schedule 80 suitable for NPT threading, and shall be made from virgin PTFE (polytetrafluoroethylene) resin conforming to ASTM D4894 Type V. Fittings having only male NPT threaded end connections shall be made from virgin PTFE resin conforming to ASTM D4894 Type V, or ASTM D4894 Type I Grade 1, and shall have pressure ratings equal to or greater than that of the schedule 80 pipe. Fittings having any female NPT threaded end connections shall be made from MICROFLON™ low-creep virgin PTFE resin conforming to ASTM D4894 Type III, Grade 1, and shall have pressure ratings equal to or greater than that of the schedule 80 pipe. The PTFE resin used by Micromold Products, Inc. conforms to FDA requirements as described in Title 21 CFR Part 177.1550, Perfluorocarbon Resins.

As in the FLUOR-O-FLO® PTFE Piping System manufactured by Micromold Products, Inc., installation shall be performed in accordance with Micromold’s Technical Bulletin: “FLUOR-O-FLO® PTFE Piping System Installation Instructions.”

For further information regarding these and other related products, please refer to other MICROMOLD PRODUCTS’ publications:

- Technical Bulletin, Pressure Ratings, FLUOR-O-FLO® PTFE Piping System.
- Sales Bulletin, FLUOR-O-FLO® PTFE NPT Piping System.
- Sales Bulletin, FLUOR-O-FLO® PTFE Tank Adapters (Bulk-head Fittings).
- Sales Bulletin, FLUOR-O-FLO® PTFE Manifolds.
- Sales Bulletin, FLUOR-O-FLO® PTFE Cam-Lock, Quick-Connect Coupling.
- Sales Bulletin, FLUOR-O-SHIELD™ PVDF & PTFE Y-Strainers.
- Sales Bulletin, FLUOR-O-SHIELD™ PVDF & PTFE Basket Strainers.
- Sales Bulletin, FLUOR-O-VALVE™ PTFE Plug Valves.

